

We are IntechOpen, the world's leading publisher of Open Access books Built by scientists, for scientists

4,900

Open access books available

123,000

International authors and editors

140M

Downloads

Our authors are among the

154

Countries delivered to

TOP 1%

most cited scientists

12.2%

Contributors from top 500 universities



WEB OF SCIENCE™

Selection of our books indexed in the Book Citation Index
in Web of Science™ Core Collection (BKCI)

Interested in publishing with us?
Contact book.department@intechopen.com

Numbers displayed above are based on latest data collected.
For more information visit www.intechopen.com



Phased Antenna Arrays Toward 5G

Tran Cao Quyen

Abstract

An antenna array for 5G has to be able to create multibeam (approximately dozens or hundreds of beams), wide azimuthal coverage (approximately 360°), and high gain (>20 dB). The analyses of four kinds of multibeam phased arrays, namely a multibeam ULA analog phased array (MULA-analog-PA), multibeam ULA digital phased array (MULA-digital-PA), multibeam cylindrical digital phased array (MC-digital-PA), and multibeam cylindrical analog phased array (MC-analog-PA), are performed. The analyses show that all arrays could provide multibeam with different complexities and computations but MULA-analog-PA and MULA-digital-PA are with maximum 180° of azimuthal coverage; whereas MC-analog-PA and MC-digital-PA are with unlimited azimuthal angle. The simulations of the MC-analog-PA with 32×10 elements (10 rings with each ring of 32 elements) show that the array could provide 32 beams symmetrical over 360° azimuthal coverage with the directivity of 27 dB. The obtained results proved the effectiveness of the phased array antennas for 5G applications.

Keywords: phased array antennas, multibeam, azimuthal coverage, cylindrical geometry

1. Introduction

5G will be at the heart of the future of communications in which the technologies such as new multiple accesses, massive MIMO, multiple beams, ultra-dense networking, etc. [1–4] are key technologies. 5G will bring new challenges for the designers of the physical infrastructure including antenna designers. Antennas for 5G have to be able to create multiple independent beams (approximately dozens or hundreds of beams), wide azimuthal coverage (approximately 360°), high gain (>20 dB), and acceptable complexity of feeding network for analog platform or powerful digital processing for digital one.

This chapter will present about multibeam phased array antennas toward 5G in terms of their principles of operation and theoretical limits. The analyses of four kinds of multibeam phased arrays, namely a multibeam ULA analog phased array (MULA-analog-PA), multibeam ULA digital phased array (MULA-digital-PA), multibeam cylindrical digital phased array (MC-digital-PA), and multibeam cylindrical analog phased array (MC-analog-PA), are performed, and some simulation results are given to demonstrate the performance of those arrays.

As is known, the phased array antennas were dating back from 60 to 80 decades with the main application of satellite communications and military radar [5–8]. In

accompany with the use of higher carrier frequencies of 5G [9–10], phased array antenna could be smaller and more compact in size with civilization application.

In order to create a main beam pointing into Θ direction, it is necessary to make phase progressive of a uniform linear array (ULA) with the phase difference of $kdc\cos\Theta$ between two consecutive elements [11]. In other words, a MULA-analog-PA having M antenna elements required M phase shifters. If this array needs N independent beams, the array must have a matrix of $M \times N$ phase shifters [12].

Due to the complexity of the design of the MULA-analog-PA, the development of digital processing leads to the invention of digital beamforming of phased array. Performing the beamforming in a multibeam digital phased array antenna is a more flexible and versatile approach. For each antenna element, it has its own amplifying module but without any phase shifters or attenuators; but it required a strong central processing unit (CPU) in order to process beamforming algorithms [13, 14].

A MULA-digital-PA could create unlimited number of independent beams, but its azimuthal coverage could not be over 180° . It is intrinsic property of an ULA. To make a solution for this problem, we need to use the circular array [14] that has 360° beam coverage in azimuthal plane. Combining the advantage of multibeam and wide azimuthal angle leads to the construction of multibeam cylindrical phased array antenna in analog or digital beamforming. MC-digital-PA is preferred if a large numbers of beams and high computing performance are required, and MC-analog-PA is suggested if a moderate numbers of beams and low cost of computing performance are required.

2. Multibeam ULA analog phased array (MULA-analog-PA)

2.1 ULA analog phased array (ULA-analog-PA)

Let us introduce the subject of phase array antenna by considering the simplest situation, namely, uniform linear analog phased array (ULA-analog-PA). An array of identical elements (in this case, isotropic elements), all of identical magnitude and each with a progressive phase and arranging in a straight line, is referred to as a uniform linear array. A typical ULA-analog-PA in which each antenna element with equal spacing, d , is illustrated in **Figure 1**.

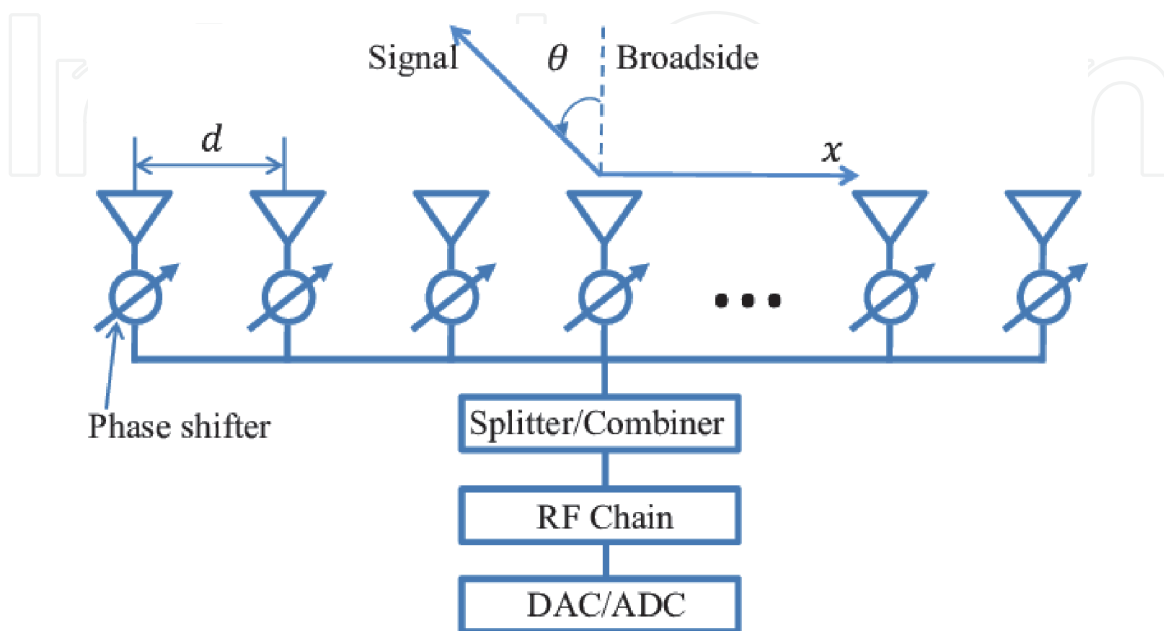

Figure 1.
A typical ULA-analog-PA.

The principle of phased array is that the phase of each antenna element is controlled by using an analog phase shifter. Assuming the array has M elements, the total field E at a large distance in the direction Θ is given by

$$E = 1 + e^{j\psi} + e^{j2\psi} + \dots + e^{j(M-1)\psi} \quad (1)$$

where ψ is the total phase difference of the fields of adjacent elements as given by

$$\psi = \frac{2\pi d}{\lambda} \cos \phi + \alpha \quad (2)$$

where α is the phase difference of adjacent elements, that is, element 2 with respect to 1, 3 with respect to 2, etc.

After some manipulation, the total field E can be written as

$$E = \frac{\sin(M\psi/2)}{\sin(\psi/2)} \quad (3)$$

The array factor which is a ratio of total field E to its maximum is given by

$$AF = \frac{E}{E_{\max}} = \frac{E}{E(\psi = 0)} \quad (4)$$

The array factor of ULA with equal amplitude, equal spacing in Z-axis, and $\alpha = 0$ (Broadside Array) is illustrated in Cartesian coordinate in **Figure 2** as follows.

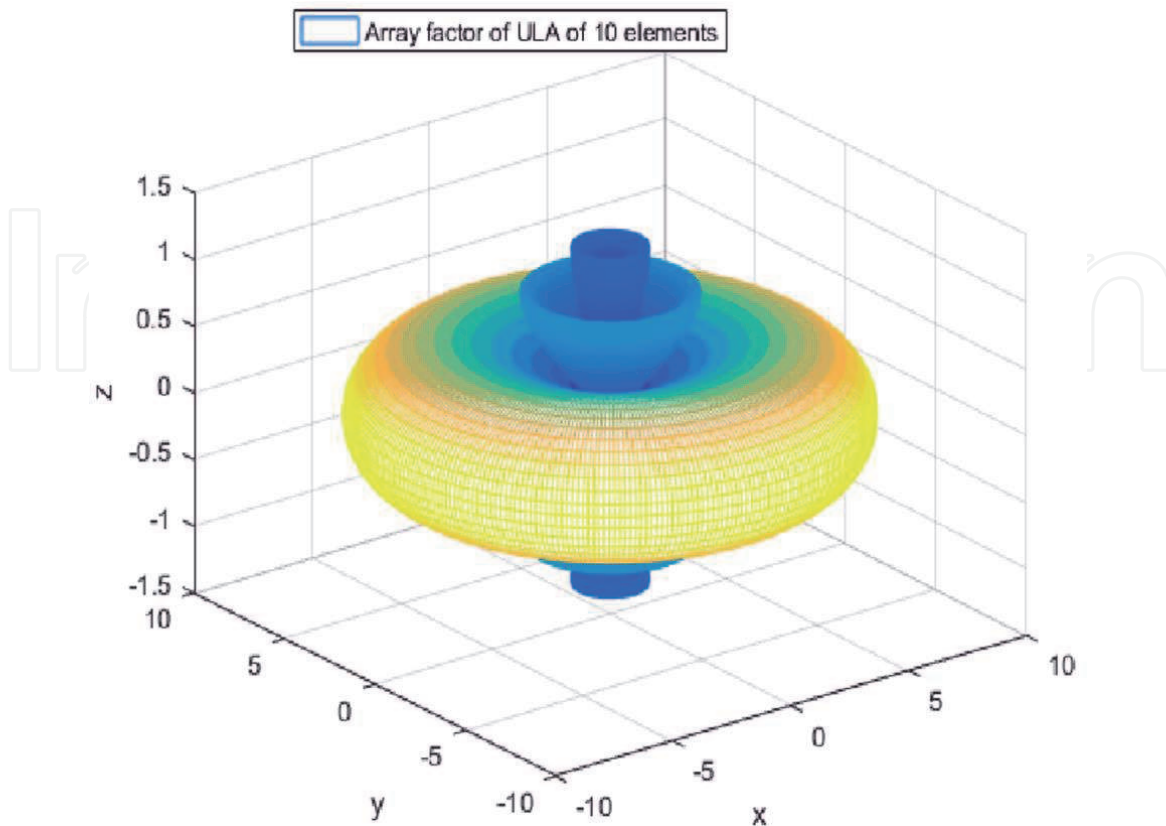

Figure 2.
 The array factor of ULA-analog-PA.

2.2 The simulation result of the ULA phased array 1×4 elements using advanced design software (ADS)

When using ADS software to design a ULA-analog-PA of 1×4 elements in X-axis, we obtain the radiated field pattern E as in **Figure 3** as follows [15].

After the analysis and some illustrations of ULA-analog-PA, we may conclude that a ULA-analog-PA could provide only one main beam and some side lobes at a time.

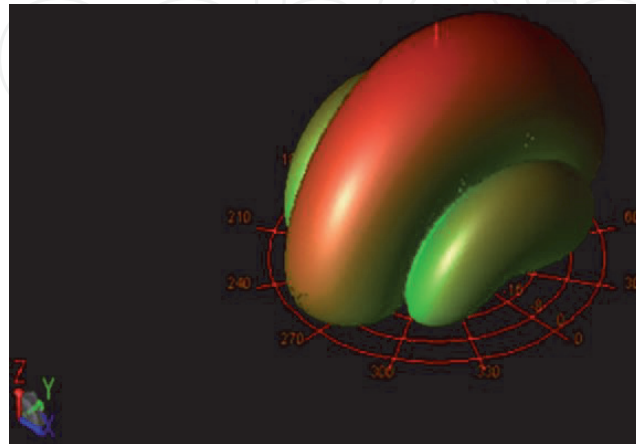

Figure 3.
The radiated field pattern of the ULA-analog-PA of 1×4 elements in X-axis.

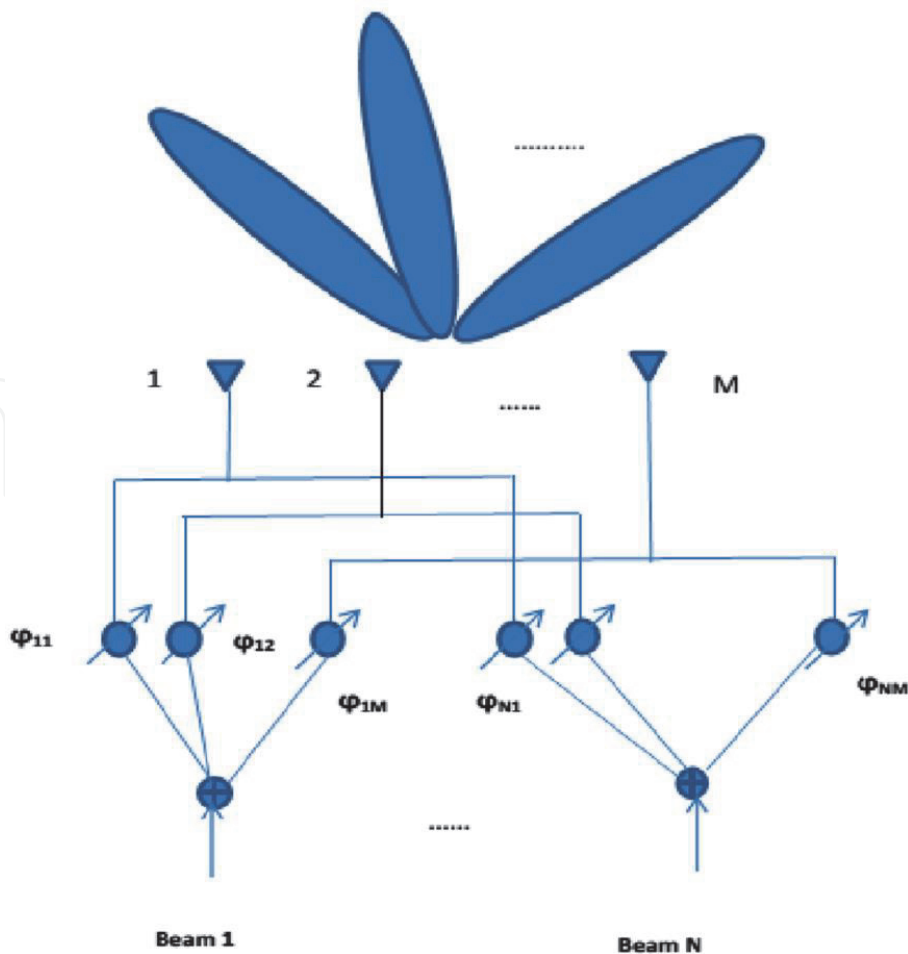

Figure 4.
A typical MULA-analog-PA.

2.3 Multibeam ULA analog phased array (MULA-analog-PA)

Now that the ULA-analog-PA has been introduced let us generalize to the construction of a MULA-analog-PA. A typical ULA-analog-PA is indicated as in **Figure 4** as follows.

In principle, a MULA-analog-PA could provide N independent beams in space. In order to drive the n^{th} beam toward Θ direction, it is necessary to make phase progressive for the corresponding ULA-analog-PA.

In another statement, the phase difference between two consecutive elements of the n^{th} beam is given by

$$\varphi_{nm} - \varphi_{n(m-1)} = -\frac{2\pi d}{\lambda} \cos \theta_n, \quad m = 2, \dots, M \quad (5)$$

To avoid grating lobe, the Nyquist condition for the distance between two consecutive elements, d , has to be satisfied. The Nyquist condition is

$$d < \frac{\lambda}{2} \quad (6)$$

The disadvantage of a MULA-analog-PA is the limit of number of independent beams due to the complexity of a matrix of $N \times M$ phase shifters or attenuators. Therefore, there is a little result for this kind of the array. Besides, the MULA-analog-PA has to deal with the problem of the limited azimuthal coverage which cannot be greater than 180° . It is one of the theoretical limits of ULA.

3. Multibeam ULA digital phased array (MULA-digital-PA)

In contrast to analog beamforming, the digital beamforming is performed without phase shifters or attenuators. MULA-digital-PA relies on a digital processing unit such as digital signal processing (DSP) or a strong computer in order to process the digital data that are the outputs of analog to digital converters (AD) and accompany with beamforming algorithms [13, 14]. The diagram of a typical MULA-digital-PA is shown in **Figure 5** as follows.

The principle of a MULA-digital-PA is that the collection of M antenna produces the received vector

$$X = [x_1, x_2, \dots, x_M], \quad m = 1, 2, \dots, M \quad (7)$$

Then, at the DSP unit, the received vector is multiplied by a matrix of weighting, W , which can be written as follows:

$$W = \begin{bmatrix} W_1 \\ W_2 \\ \vdots \\ W_M \end{bmatrix} = \begin{bmatrix} W_1 \cdots W_{1M} \\ W_2 \quad \vdots \\ \vdots \\ W_M \cdots W_{NM} \end{bmatrix} \quad (8)$$

where the component weighting is given by

$$W_n = \left[1, \exp \left(j \frac{2\pi}{\lambda} d \cos \theta \right), \dots, \exp \left(j \frac{2\pi}{\lambda} nd \cos \theta \right) \right] \quad (9)$$

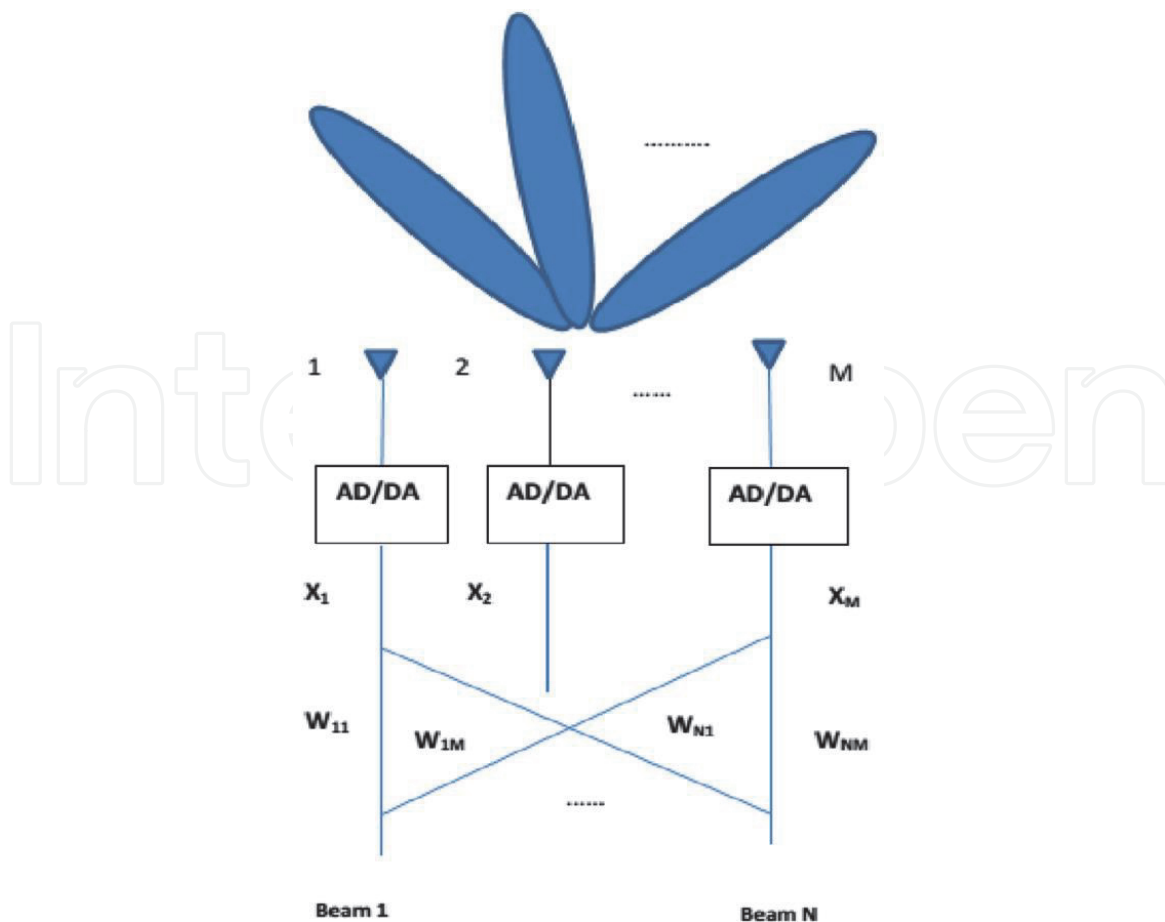

Figure 5.
A typical MULA-digital-PA.

Therefore, the output of DSP is

$$Y_n(\theta) = W_n^H X \quad (10)$$

Finally, other constraints on the output of DSP is performed.

The advantage of MULA-digital-PA is that performing the beamforming is a more flexible and versatile approach. However, the array still has limited azimuthal coverage which cannot be greater than 180° since it is one of the theoretical limitations of ULA. In order to cover the azimuthal angle of 360° , we have to use at least three MULA-digital-PAs.

4. Multibeam cylindrical analog phased array (MC-analog-PA) of $M \times N$ elements

The objectives in many designs for 5G antenna are multiple independent beams (approximately dozens or hundreds of beams), wide azimuthal coverage (approximately 360°), and high gain (>20 dB). A MC-analog-PA of $M \times N$ elements has both the characteristics of multibeam and wide azimuthal coverage since it exploited the characteristics of not only of MULA-analog-PA but also of cylindrical geometry, that is, perfect symmetrical over Z-axis. However, since the array relies on analog technology, the number of beams is limited by the number of phase shifters. The geometry of a MC-analog-PA of $M \times N$ elements is shown in Cartesian coordinate in **Figure 6** as follows.

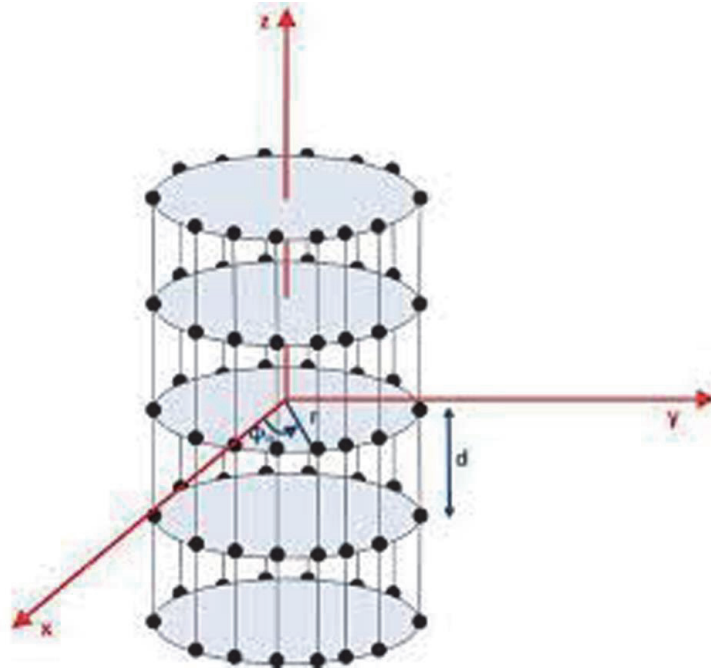

Figure 6.
 The geometry of MC-analog-PA of $M \times N$ elements (each ring has M elements).

In this case, the array factor is given by [16].

$$AF_{cylinder}(\varphi, \theta) = AF_{ring}(\varphi, \theta)AF_{linear}(\varphi, \theta) \quad (11)$$

where $AF_{ring}(\varphi, \theta)$ is the array factor of the circular array [17] in XOY plane and $AF_{linear}(\varphi, \theta)$ is the array factor of ULA-analog-PA in Z-axis.

Generally, the array factor of an array having M elements in space is given by

$$AF(\varphi, \theta) = I_1 e^{-j\beta\Delta r_1} + \dots + I_M e^{-j\beta\Delta r_M} = \sum_{k=1}^M I_k e^{-j\beta\Delta r_k} \quad (12)$$

where $\Delta r_k = r_k \cdot a_r = x_k \cos \theta \sin \varphi + y_k \sin \theta \sin \varphi + z_k \cos \varphi$ is the phase difference of the K^{th} element to the reference element, I_k is the excited current of the K^{th} element, r_k is position vector of the K^{th} element, and a_r is directional unit vector.

The directivity of an antenna can be approximated as [16].

$$D_{\max} = \frac{4\pi}{HPBW_{\theta} \cdot HPBW_{\varphi}} \approx \frac{41253}{HPBW_{\theta} \cdot HPBW_{\varphi}} \quad (13)$$

where half power beam width in Θ plane, $HPBW_{\theta}$, is perpendicular to the half power beam width in ϕ plane, $HPBW_{\varphi}$.

4.1 The simulation result of the multibeam circular analog phased array of 32 elements

To illustrate the performance of MCr-analog-PA, we do some simulations. First, isotropic antenna elements are arranged symmetrical in a circular with the reservation of the Nyquist condition of the distance between two consecutive elements.

Second, uniform currents are excited for all elements then the array factor of MCr-analog-PA of 32 elements is calculated (Eq. (12)) and depicted in Cartesian coordinate in **Figure 7** as follows.

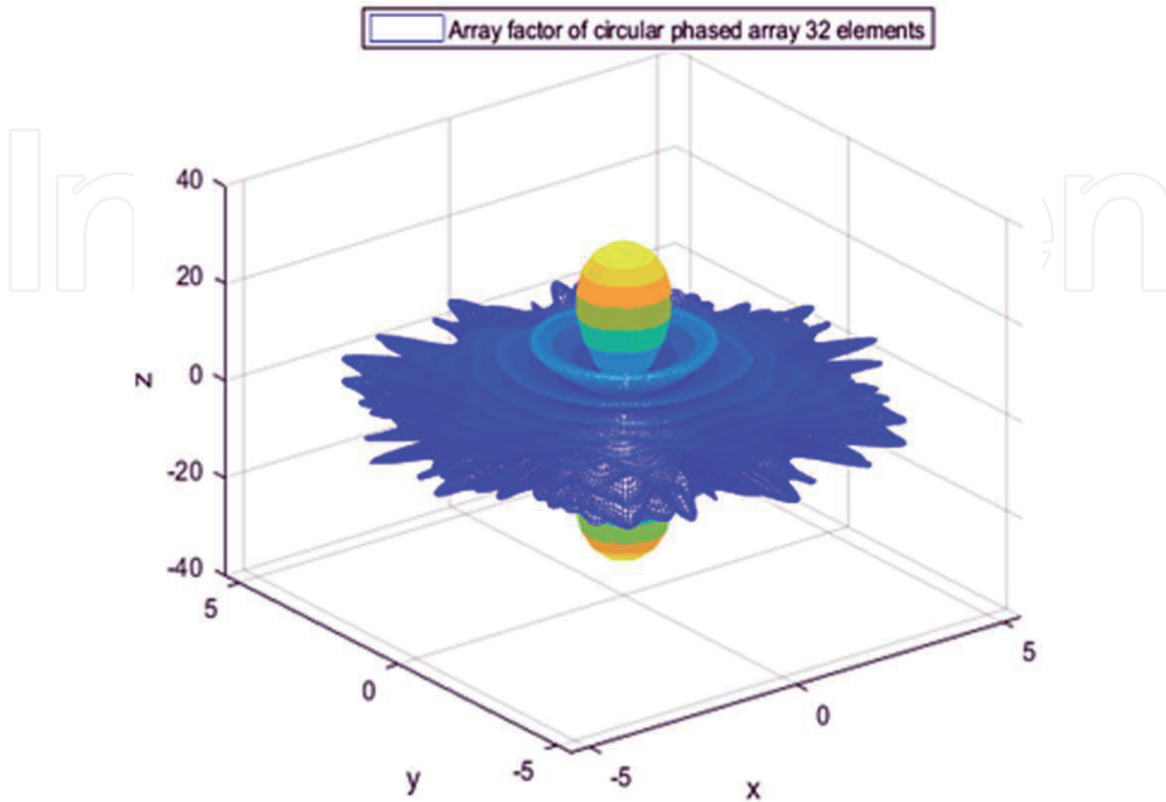

Figure 7.
The array factor of MCr-analog-PA of 32 elements.

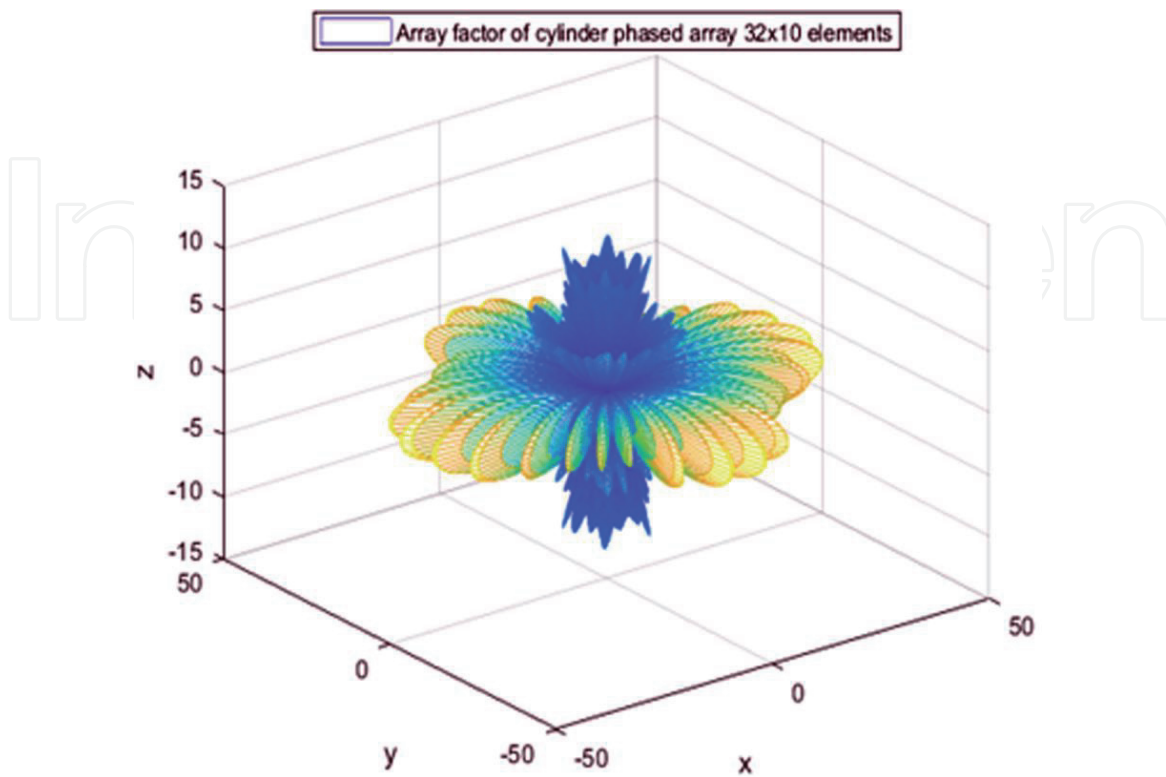

Figure 8.
The array factor of MC-analog-PA of 32×10 elements.

4.2 The simulation result of the multibeam cylindrical analog phased array of 32×10 elements

When combining 10 rings of Section 4.1 in Z-axis with each ring spaced by $\lambda/2$ (half of wave length), we obtain the MC-analog-PA of 32×10 elements. The array factor of the MC-analog-PA of 32×10 elements is calculated [Eqs. (11) and (12)] and depicted in Cartesian coordinate as in **Figure 8** as follows.

From the result in **Figure 8**, we can see that the array can produce 32 independent beams symmetrical in azimuthal plane.

Since $HPBW_{\theta} = HPBW_{\varphi} \approx 9^{\circ}$, the directivity of the MC-analog-PA of 32×10 elements can be approximated as

$$D_{cylinder} = \frac{41253}{(9) \cdot (9)} \approx 509 \approx 27dB \quad (14)$$

From the obtained results of the multibeam over azimuthal angle of 360° and directivity of the array, we may conclude that the MC-analog-PA of 32×10 elements can meet the requirements of multibeam, wide azimuthal coverage and high gain of 5G applications.

5. Multibeam cylindrical digital phased array (MC-digital-PA)

Let us introduce the last array of this chapter, namely, multibeam cylindrical digital phased array (MC-digital-PA). The MC-digital-PA of $M \times N$ elements is the expanding of a MULA-digital-PA combing with a cylindrical geometry. Therefore, it has both the characteristics of multibeam and wide azimuthal coverage. Especially, not only the array structure follows the cylindrical geometry as described in Section 4 but also the digital beamforming is performed using DSP units or a strong computer accompany with beamforming algorithms.

Generally, if huge beams and 360 azimuthal angle are required, the MC-digital-PA will become a promising candidate. The only shortcoming of the MC-digital-PA is the cost of intensive computations.

6. Conclusions

The analyses of MULA-analog-PA, MULA-digital-PA, MC-analog-PA, and MC-digital-PA show that all arrays could provide multibeam with different complexities and computations but MULA-analog-PA and MULA-digital-PA are with maximum 180° of azimuthal coverage; whereas MC-analog-PA and MC-digital-PA are with unlimited azimuthal angle. The simulations of the MC-analog-PA with 32×10 elements (10 rings with each ring of 32 elements) show that the array could provide 32 beams symmetrical over 360 azimuthal coverage with the directivity of 27 dB. In view of antenna design, those arrays are possible candidates for 5G applications.

Acknowledgements

This work is partially supported by the Vietnam National University, Hanoi (VNUH).

Abbreviations

ADS	advanced design software
DA/AD	digital to analog converter/analog to digital converter
DSP	digital signal processing
MIMO	multiple output multiple input
MULA-analog-PA	multibeam uniform linear phased array of analog technology
MULA-digital-PA	multibeam uniform linear phased array of digital technology
MC-analog-PA	multibeam cylindrical phased array of analog technology
MC-digital-PA	multibeam cylindrical phased array of digital technology
MCr-analog-PA	multibeam circular phased array of analog technology
ULA	uniform linear array
ULA-analog-PA	uniform linear array of analog technology

IntechOpen

Author details

Tran Cao Quyen
University of Engineering and Technology, Hanoi, Vietnam

*Address all correspondence to: quyentc@vnu.edu.vn

IntechOpen

© 2020 The Author(s). Licensee IntechOpen. This chapter is distributed under the terms of the Creative Commons Attribution License (<http://creativecommons.org/licenses/by/3.0>), which permits unrestricted use, distribution, and reproduction in any medium, provided the original work is properly cited. 

References

- [1] Chin WH, Fan Z, Haines R. Emerging technologies and research challenges for 5G wireless networks. *IEEE Wireless Communications Magazine*. 2014;**21**(2):106-112. DOI: 10.1109/MWC.2014.6812298
- [2] Shaf M, Molisch AF, Smith PJ, et al. 5G: A tutorial overview of standards, trials, challenges, deployment, and practice. *IEEE Journal on Selected Areas in Communications*. 2017;**35**(6):1201-1221. DOI: 10.1109/JSAC.2017.2692307
- [3] Asteley D et al. LTE: The evolution of mobile broadband. *IEEE Communications Magazine*. 2009;**47**(4):44-51. DOI: 10.1109/MCOM.2009.4907406
- [4] Larsson EG, Edfors O, Tufvesson F, Marzetta TL. Massive MIMO for next generation wireless systems. *IEEE Communications Magazine*. 2014;**52**(2): 186-195. DOI: 10.1109/MCOM.2014.6736761
- [5] Zaghoul AI, Hwang Y, Sorbello RM, Assal FT. Advances in multibeam communications satellite antennas. *Proceedings of the IEEE*. 1990;**78**(7): 1214-1232. DOI: 10.1109/5.56934
- [6] Jain A. Multibeam synthetic aperture radar for global oceanography. *IEEE Transactions on Antennas and Propagation*. 1979;**27**(4):535-538
- [7] Brautigam B, Schwerdt M, Bachmann M. An efficient method for performance monitoring of active phased array antennas. *IEEE Transactions on Geoscience and Remote Sensing*. 2009;**47**(4):1236-1243. DOI: 10/1109/TGRS.2008.2008719
- [8] Agrawal A, Kopp B, Luese MH, Haver KW. Active phased array development for modern shipboard radar systems. *Johns Hopkins APL Technical Digest*. 2001;**22**(4):600-613
- [9] Carey E, Lidholm S. *Millimeter-Wave Integrated Circuits*. Berlin, Germany: Springer; 2005. DOI: 10.1007/b102136
- [10] Marcus MJ. 5G and 'IMT for 2020 and beyond. [spectrum policy and regulatory issues]. *IEEE Wireless Communications*. 2015;**22**(4):2-3. DOI: 10.1109/WMC.2015.7224717
- [11] Hansen RC. *Phased Array Antennas*. New York: Wiley Interscience; 2009. DOI: 10.1002/9780470529188
- [12] Hong W, Jiang ZH, Yu C, et al. Multibeam antenna technologies for 5G wireless communications. *IEEE Transactions on Antennas and Propagation*. 2017;**65**(12):6231-6249. DOI: 10.1109/TAP.2017.2712819
- [13] Litva J, Lo TKY. *Digital Beamforming in Wireless Communication*. Boston, London: Artech House; 1996. ISBN: 0-89006-712-0
- [14] Balanis C. *Introduction to Smart Antenna*. California, USA: Morgan and Claypool Publishers; 2007. ISBN: 1598291769
- [15] Quyen TC. Developing a symmetrical phased array antenna with low complexity. *IEEE: 7th International Conference on Integrated Circuit, Design and Verification (ICDV)*. Hanoi, Vietnam; 2017. pp. 133-137. DOI: 10.1109/ICDV.2017.8188653
- [16] Kraus J. *Antennas*. 2nd ed. New Delhi: Tata McGraw-Hill. ISBN: 0-07-463219-1
- [17] Jackson BR, Rajan S, Liao BJ, Wang S. DOA estimation using directive antennas in uniform circular array. *IEEE Transactions on Antennas and Propagation*. 2015;**63**(2). DOI: 10.1109/TAP.2014.2384044